

SITUAÇÃO SEM ESCALA

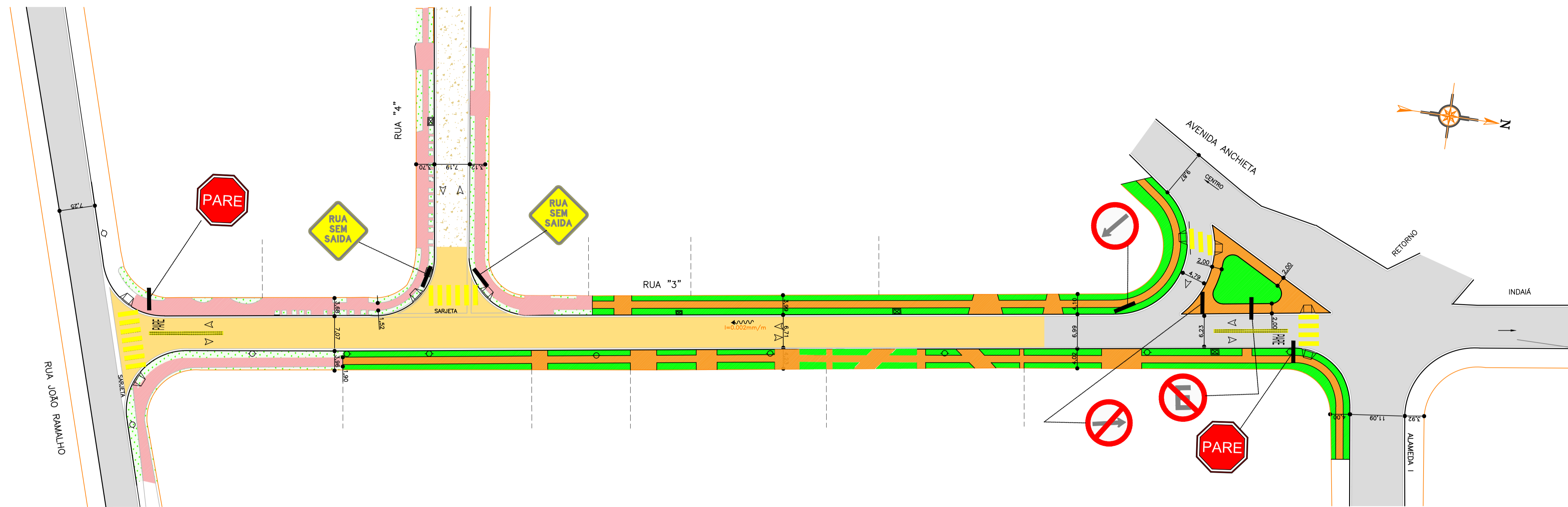

OBS: OS COMPRIMENTOS INDICADOS DE GALÉRIAS SÃO ENTRE POÇOS DE VISITA

DETALHAMENTO GUIA REBAIXADA

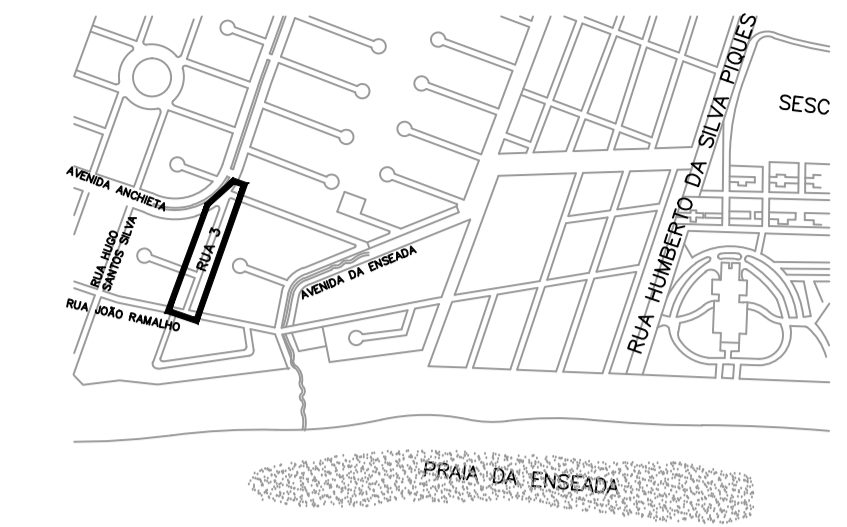

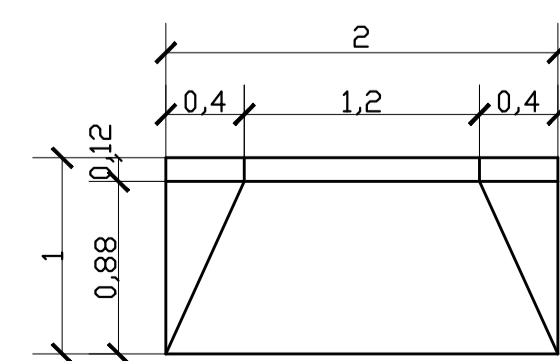

SEM ESCALA

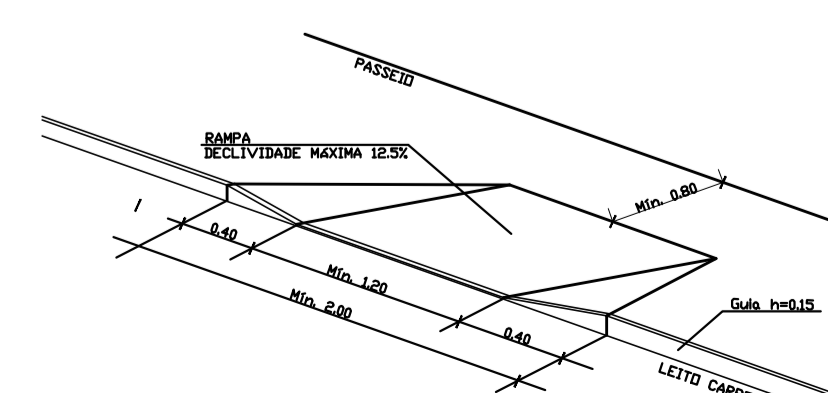

PLANTA DA GUIA REBAIXADA SEM ESCALA



ACESSIBILIDADE NBR 9050 - PERSPECTIVA DA GUIA REBAIXADA SEM ESCALA

| SINAIS | NOME |  | Rua sem saída |
|---|---------------------|---|------------------------------|
|  | Proibido estacionar |  | Parada Obrigatória |
|  | Sentido proibido |  | Sentido de circulação da via |

| | | |
|---|--------|------------|
|  PREFEITURA DE Bertioga JUNTOS FAZEMOS MELHOR | | DESENHISTA |
| | | TOPÓGRAFO |
| ASSUNTO: OBRAS DE INFRAESTRUTURA LOCAL: RUA 3 - MATINGA TÍTULO: PROJETO DE SINALIZAÇÃO | | DATA |
| ENG. CIVIL ANA LUCIA LUCHESE CREA 0601719268 | | MARÇO/2018 |
| ESCALA | 1/1000 | FOLHA |
| | | 04/04 |